

QUICK START GUIDE

AUTEL Smart Remote Controller

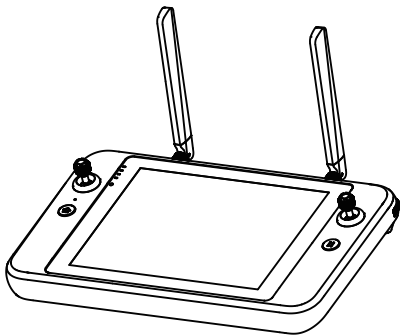

AUTEL
ROBOTICS

Contents

1. Disclaimer	1
2. Battery safety	1
3. Precautions	1
4. Getting to know Autel smart remote controller	2
5. Item list	2
6. Component Layout	4
7. Powering on the remote controller	5
7.1 Check the battery information	5
7.2 Power on/off	6
7.3 Charging	6
8. Antenna Adjustment	6
9. Frequency Match	7
10. Flying	8
11. Joystick Operations (Mode 2)	9
12. Specifications	10

1. DISCLAIMER

To ensure safe and successful operation of your Autel smart remote controller, please strictly follow the operating instructions and steps in this guide.

If the user does not abide by the safety operation instructions, Autel Robotics will not be responsible for any product damage or loss in use, whether direct or indirect, legal, special, accident or economic loss (including but not limited to loss of profit), and does not provide warranty service. Do not use incompatible parts or use any method that does not comply with the official instructions of Autel Robotics to modify the product.

The safety guidelines in this guide will be updated from time to time. To ensure you get the latest version, please visit the official website:
<https://www.autelrobotics.com/>

2. BATTERY SAFETY

The Autel smart remote controller is powered by a smart lithium-ion battery. Improper use of lithium-ion batteries can be dangerous. Please ensure that all the following battery usage, charging and storage guidelines are strictly followed.

WARNING:

- Only use the battery and charger provided by Autel Robotics. It is forbidden to modify the battery assembly and its charger or use a third-party equipment to replace it.
- The electrolyte in the battery is extremely corrosive. If electrolyte spills into your eyes or skin accidentally, please rinse the affected area with clean water and seek medical attention in time.

3. PRECAUTIONS

When using the Autel smart remote controller (hereinafter referred to as the "remote controller"), if the operation is improper, the aircraft may cause a certain degree of injury and damage to personal and property. Please be cautious when using it. For details, please refer to the aircraft's disclaimer and safety operation guidelines.

1. Before each flight, make sure that the remote controller is fully charged.
2. Make sure that the remote controller antennas are unfolded and adjusted to a suitable position to ensure it working in the best conditions.







3. If the remote controller antenna is damaged, it will affect the performance, please contact the after-sales technical support in time.
4. If the aircraft is changed, it needs to be re-paired before using.
5. Make sure to turn off the aircraft power before turning off the remote controller each time.
6. Make sure to fully charge the remote control every three months.
7. Once the power of the remote control is lower than 10%, please charge the remote in time to prevent the over discharge issue which caused by the long-time storage with low battery level. When the battery is not in use for a long time, please discharge the battery to about 40%~60% first before storage.
8. Do not block the air outlet of the remote controller, to prevent the remote controller overheating and performance decrease.
9. Do not disassemble the remote controller. If you need to replace the components, please be sure to contact Autel Robotics after-sales.

4. AUTEL SMART REMOTE CONTROLLER

The Autel smart remote controller can be used with any supported aircraft, and it provide high-definition real time image transmission. With the complete function buttons of the remote control, it can control and setup the aircraft and camera up to 13km (8.08miles) ^[1] communication distance. The remote controller has a built-in 7.9-inch 2048x1536 ultra-high-definition, ultra-bright screen with a maximum 2000nit brightness. It provides clear image display under the strong sunlight. With it built-in 128G memory, it's convenient to store the video footages in time. The working time is about 3 hours when the built-in battery is fully charged and the screen is at the maximum brightness ^[2].

5. ITEM LIST

NO	DIAGRAM	ITEM NAME	QTY
1		7.9 inch Smart Remote Controller	1PC

2		Remote Controller Protective Case	1PC
3		A/C adapter	1PC
4		USB Type-C cable	1PC
5		Chest Strap	1PC
6		Spare joysticks	2PCS
7		Documentation (Quick Start Guide)	1PC

[1] Fly in an open, unobstructed, electromagnetic interference-free environment, and the flight altitude is about 120 meters (393 feet), the remote controller can reach the maximum communication distance under the FCC standard. Due to interference in the actual flight environment, the maximum communication distance may be less than this nominal distance, and it will vary with the intensity of the interference.

[2] The above-mentioned working time is measured in a laboratory environment (temperature is room temperature). The battery life varies in different usage scenarios, which is for reference only.

6. COMPONENT LAYOUT

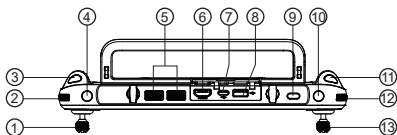

Top view

- | | | |
|-----------------------------|----------------------------|--------------------------|
| 1. Left Joystick | 5. Air outlet | 11. Gimbal Control Wheel |
| 2. Gimbal Pitch Angle Wheel | 6. HDMI Port | 12. Photo Shutter Button |
| 3. Video Recording Button | 7. USB TYPE-C Port | 13. Right Joystick |
| 4. Customizable Button C1 | 8. USB TYPE-A Port | |
| | 9. Power Button | |
| | 10. Customizable Button C2 | |

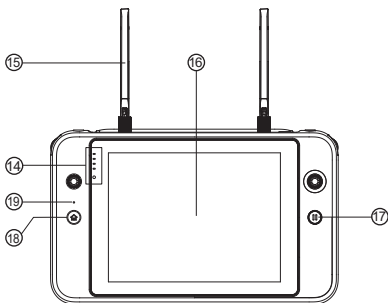

Front view

- | | |
|-----------------------|---------------------------------|
| 14. Battery Indicator | 17. Pause Button |
| 15. Antenna | 18. Return to Home (RTH) Button |
| 16. Touch Screen | 19. Micphone |

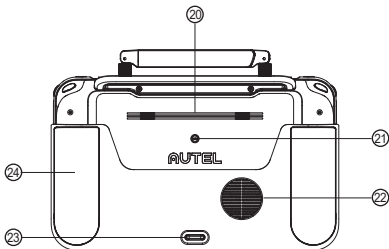

Rear view

20. Speaker Hole

21. Tripod Mount Hole

22. Air Inlet





23. Bottom Hook

24. Protection Guard

7. POWER ON THE REMOTE CONTROLLER

7.1 Check Battery Level

Press the power button to check the battery life





	<p>1 light solid on: Battery \geq 25%</p>
	<p>2 lights solid on: Battery \geq 50%</p>
	<p>3 lights solid on: Battery \geq 75%</p>
	<p>4 lights solid on: Battery \geq 100%</p>

7.2 Powering on/off

Press and hold the power button for 2 sec to turn on and off the Remote Controller

7.3 Charging

Remote Controller indication light status

	1 light solid on: Battery \geq 25%
	2 lights solid on: Battery \geq 50%
	3 lights solid on: Battery \geq 75%
	4 lights solid on: Battery \geq 100%

 **NOTE:** LED indication light will blink while charging

8. ANTENNA ADJUSTMENT

Unfold the remote controller antenna and adjust the antenna angle. The signal strength varies when the antenna angle is different. When the antenna and the back of the remote controller are at an angle of 180° or 260°, and the antenna surface is facing the aircraft, the signal quality of aircraft and remote controller will reach the best condition. When controlling the aircraft, please ensure the aircraft is within the best communication range.

NOTE:

LED indicator will flash while charging

- Do not use other communication equipment which has the same frequency band at the same time, to avoid the interference to the remote controller signal.

- In actual operation, Autel Explorer will prompt when the image transmission signal is poor. Please adjust the antenna angle according to the prompts to ensure that the aircraft is in the best communication range.

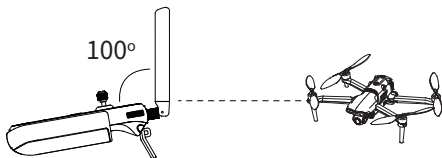

9. FREQUENCY MATCH

When the remote controller and the aircraft are purchased as a set, the remote controller has been matched to the aircraft at the factory, and it can be used directly after the aircraft is activated.

If purchased separately, please use the following methods to link.

1. Press (short press) the linking button next to the USB port on the right side of the aircraft body to put the aircraft into the linking state;
2. Open the remote controller and run Autel Explorer, enter the mission flight interface, click the gear icon in the upper right corner, enter the settings menu, click "remote control -> data transmission and image transmission linking-> start linking", wait a few seconds until the data transmission is set correctly and the linking is a success.





10. FLIGHT

Open the Autel Explorer app and enter the flight interface.

Before takeoff, place the aircraft on a flat and level surface and face the rear side of the aircraft towards you.

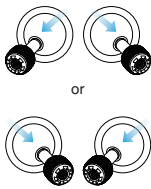
Manual takeoff and landing (Mode 2)

Toe in or out both hands and stay about 2 sec:

Manual Takeoff	
 <p>or</p>	 <p>Push up slowly Left Joystick (mode 2)</p>
Manual landing	Automatic takeoff and landing
 <p>Push down slowly Left Joystick (Mode 2)</p>	 <p>Press and hold the take-off/landing button 3 seconds</p>

NOTE:

Before takeoff, place the aircraft on a flat and level surface and face the rear side of the aircraft towards you.

Mode 2 is the default control mod of the remote controller. During the flight, you can use the left stick to control the flight altitude and direction, and use the right stick to control the forward, backward, left and right direction of the aircraft.

NOTE:

- Please make sure that the remote controller has successfully matched with the aircraft.
- For more functions of the remote controller, please read the user manual for details

11. Command Stick Control (Mode 2)

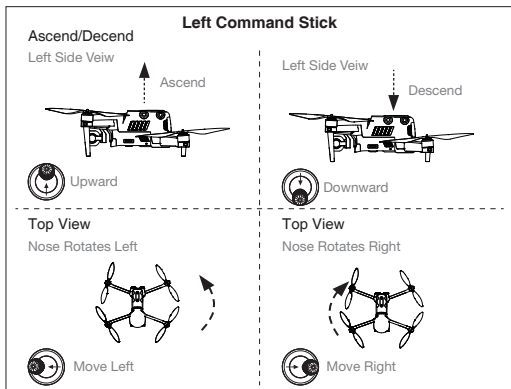

Right Command Stick

Left Side Veiw

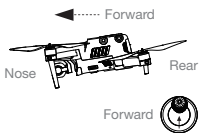

Left Side Veiw

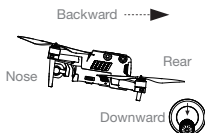

Rear View

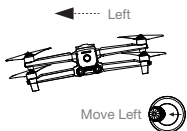

Rear View

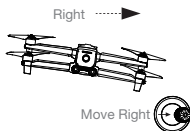

12. Specifications

Image Transmission

Max Signal Transmission
Distance
(No interference, No
obstacles)

FCC: 13 km
CE / MIC: 7 km
SRRC: 7 km

Digital transmission

Working Frequency

5.725 - 5.755 GHz

Wi-Fi

Protocol

Wi-Fi Direct, Wi-Fi Display,
802.11a/b/g/n/ac
Support 2 x 2 MIMO Wi-Fi

* Working Frequency	2.400 - 2.4835 GHz; 5.150 - 5.250GHz; 5.650 - 5.755GHz; 5.725 - 5.850 GHz 902 - 928MHz
---------------------	--

Other Specifications

Battery	Name: Intelligent Li-ion battery Capacity: 5800mAh Voltage: 11.55V Battery Type: Li-ion Battery Energy: 67 Wh Charging time: 120 min
Operating Hours	~ 3h (Max Brightness) ~ 4.5 h (50% Brightness)
Internal Storage	128GB
Video Output port	HDMI Port
USB-A Voltage/Current	5V / 2A
Operating Environment Temp	-20 °C to 40 °C
Storage temperature	-20 °C to 60 °C (within a month) -20 °C to 45 °C (between one to three months) -20 °C to 23 °C (one year)
Charging Environment Temp	0 °C to 40 °C
Supported Aircrafts	EVO II Series EVO II RTK Series EVO II Enterprise
Satellite Positioning Module	GPS + GLONASS + Galileo
Dimensions	303×190×87mm (with antenna folded) 303×273×87mm (with antenna unfolded)
Weight	1150g (without protection case) 1250g (with protection case)

 **NOTE:**

- When external devices are connected and powered by the remote controller, the battery life may reduce.
- We will support more Autel Robotics aircrafts in the future, please visit our official website <https://www.autelrobotics.com/> for the latest information.
- * The working frequency band varies according to different countries and models.

AUTEL

WWW.AUTELROBOTICS.COM

© 2020-2021 Autel Robotics Co., Ltd. All Rights Reserved